

3991

T- 3336/19



পশ্চিমবঙ্গ পশ্চিম বঙ্গাল WEST BENGAL

E 456552

9/855171  
V/c-875

CERTIFIED THAT THE DOCUMENT IS ADMITTED TO REGISTRATION.  
THE SIGNATURE SHEET AND THE ENFORCEMENT SHEETS ATTACHED  
TO THIS DOCUMENT ARE THE PARTS OF THIS DOCUMENT

Adtl. District Sub-Registrar,  
Sikhar-II at Bagdogra

17 JUN 2019

MAHATA AQUA PRIVATE LIMITED  
*Neuman Khan*  
Director

*Neeraj*

# DEED OF CONVEYANCE

Contd. To next sheet

SL NO. 5277 Date 31.5.2019  
PURCHASER Shital Mittal  
Full Address Kusron  
Total Value ₹ 500/-  
Stamp Purchased from JPG Treasury-1



*JMS*  
**STAMP VENDOR**  
**JAYA RANI DAS**  
Licence No.1 of 99-2000  
Addl. DSR Office, Rajganj, Jalpaiguri

NAHATA AQUA PRIVATE LIMITED  
*Jawan Hasan*  
Director  
280004 B



*2780*

NAHATA AQUA PRIVATE LIMITED  
*Jawan Hasan*  
Director

Purna Pal  
S. Narendra Nath Pal  
Sevra Road, Sitiguri  
Pin: 734001



Registrar  
Dist. Darjeeling

NAHATA AQUA PRIVATE LIMITED  
Director  
Suman Kumar

**DEED OF CONVEYANCE**

THIS INDENTURE MADE THIS THE  
10<sup>th</sup> DAY OF JUNE 2019

**CONVEYANCE**

**PARGANA- PATHARGHATA**

**MOUZA-BARAGHARIA**

**P. S-MATIGARA**

**DIST. DARJEELING**

**AREA: 3(THREE) KATHAS**

**SET FORTH VALUE**

**Rs.11,14,000/=**

**L. R. KHATIAN NO. 1467**

**R. S. PLOT NO. 266**

**L. R. PLOT NO. 219**

**J. L. NO. 82**

**SHEET NO. 1**

**GRAM PANCHAYAT**

**BETWEEN**

**SMT SHITAL MITTAL**(P. A. No. AIUPA8496Q) W/O Sri Hemant Mittal & D/O Sri Sumat Prasad Agarwal, Hindu by Religion, Business by Occupation, Citizen by Indian, residing at 13<sup>th</sup> Park Location, P.O, P.S, S.D, S.R.O, Kurseong, District Darjeeling, Pin-734203, in the State of West Bengal, hereinafter called the "**PURCHASER**"(which expression shall mean and include her heirs, executors, administrators, legal representatives and assigns) of the **ONE PART**.

Contd. to next sheet

NAHATA AQUA PRIVATE LIMITED  
Jeevan Sharma

AND

**“NAHATA AQUA PRIVATE LIMITED”**(P. A. No.AAECN4576F), a Private Limited Company, incorporated under the companies Act 1956, having its corporate Identity Number:- U15543WB2010PTC152216, dated 12-08-2010, having its Registered Office at 404, Ganga Apartment, Mangal Pandey Road, Khalpara, Siliguri-734005, P.O & P.S-Siliguri, Dist. Darjeeling, in the State of West Bengal, represented by one of its Director **SRI JEEWAN CHAND SHARMA**(P. A. No. AKVPS8264M) S/O Late Debi Dutt Sharma, Hindu by Religion, Business by Occupation, Citizen by Indian, residing at Shagun Apartment, Gandhi Road, Darjeeling, P.O. Darjeeling, P.S-Sadar Thana, Dist-Darjeeling, Pin-734101, in the State of West Bengal, hereinafter called the **“VENDOR”**(Which expression shall and include its directors, executors, administrators, office representatives and assigns) of the **OTHER PART**.

**WHEREAS** the Vendor is the absolute owner in possession of all that piece or parcel of land measuring **499.71(Four Hundred Ninety Nine Point Seven One)** Decimals, appertaining to R. S. Plot Nos. **81, 82, 83, 265, 266, 268, 274 & 279** corresponding to L. R. Plot Nos. **204, 210, 211, 217, 218, 219, 220, 221, 228, 229 & 230**, situated at Mouza-**BARAGHARIA**, J. L. No. **82**, Pargana-Patharghata, Police Station-Matigara, Addl. District Sub-Registry Office Siliguri-II at Bagdogra, District-Darjeeling, by virtue of Fourteen Deed of Conveyances, i). being Document No. 05392, for the year 2013, ii). being Document No. 05393, for the year 2013, iii). being Document No. 06465, for the year 2014, iv). being Document No. 040306680, for the year 2016, v). being Document No. 040306683, for the year 2016, vi). being Document No. 040306684, for the year 2016, vii). being Document No. 040300097, for the year 2017, viii). being Document No. 040300098, for the year 2017, ix). being Document No. 040300099, for the year 2017, X). being Document No. 040300100, for the year 2017, Xi). being Document No. 040300103, for the year 2017, Xii). being Document No. 040300104, for the year 2017, Xiii). being Document No. 040300106, for the year 2017 & Xiv). being Document No. 040300117, for the year 2017,

Meer

Contd. to next sheet

MAHATA AGUA PRIVATE LIMITED  
Jeevan / Harun  
Director

registered at A. D. S. R. Siliguri-II at Bagdogra, executed by **SRI DEEPAK KUMAR AGARWAL & Others** of Siligur, District-Darjeeling and shall ever since then Vendor have been in exclusive and peaceful possession of the said land without any act of hindrance or obstruction from anybody and the aforesaid land is fully described in the schedule below.

**AND WHEREAS** thereafter the Vendor recorded the aforesaid land in its names in the record of rights at the Office of B. L. & L. R. O Shivmandir and shall ever since One new L. R. Khatian, being Khatian No. 1467 was framed in the name of Vendor, as per provision of W. B. L. R. Act 1955.

**AND WHEREAS** by Virtue of the aforesaid Deed of Conveyance & Record of Rights Vendor has become the sole, absolute and exclusive owner of the aforesaid Land measuring 499.71(Four Hundred Ninety Nine Point Seven One) Decimals, more particularly described in the Schedule hereunder, having permanent heritable and transferable right, title and interest therein

**AND WHEREAS** the Vendor being in need of fund for investing the some lucrative business and for other family expenses have offer for sale the above referred land measuring 3(Three) Kathas, out of total purchased land measuring 499.71(Four Hundred Ninety Nine Point Seven One) Decimals, for a total consideration of Rs.11,14,000/-(Rupees Eleven Lakhs Fourteen Thousand) only and the aforesaid land is fully described in the Schedule herein below.

**AND WHEREAS** the Purchaser having learnt the intention of the Vendor to sell the aforesaid land fully described in the schedule herein below approached the Vendor and offered to Purchase the above referred land measuring 3(Three) Kathas, for a total consideration of Rs.11,14,000/-(Rupees Eleven Lakhs Fourteen Thousand) only.

**AND WHEREAS** the Vendor finding the said offer of the Purchaser lucrative and profitable, have accepted the same and agreed to sell to the Purchaser the said land measuring 3(Three) Kathas, free from all encumbrances for a total consideration of Rs.11,14,000/-(Rupees Eleven Lakhs Fourteen Thousand) only.

Contd. to next sheet

My

MAHATA AGUA PRIVATE LIMITED  
Director  
*Goway Kauram*

**AND NOW THIS INDENTURE WITNESSES AS FOLLOWS:-**

THAT in pursuance of the said offer and acceptance and also in consideration of Rs.11,14,000/-(Rupees Eleven Lakhs Fourteen Thousand) only paid by the Purchaser to the Vendor, the receipt hereof the Vendor does hereby acknowledge and grant full discharge to the Purchaser from the payment thereof, the Vendor does hereby grant, assign, convey and transfer unto the Purchaser the aforesaid land as fully described in the schedule hereunder and also makes over khas and peaceful possession thereof to the Purchaser together with all rights, including all liabilities, privileges, easements, appendices, appurtenances whatsoever in any way belonging to or in any manner appertaining thereto as absolute estate right, title and interest and unto and upon the land hereby conveyed, expressed or intended so to be **TO HAVE AND TO HOLD** the same subject to the payment of rents etc to the superior Landlord the State of West Bengal.

That the Vendor does hereby covenant with the Purchaser that the Purchaser may and shall at all times hereafter hold, possess and enjoy the said land as fully described in the schedule below and without any obstruction, interruption or disturbance by the Vendor or any person claiming through or under him.

AND

That the Vendor does hereby covenant with the Purchaser that the right, title and interest in the land as fully described in the schedule below and which the Vendor does hereby transfer subsist and the Vendor has good power and full authority to transfer the land hereby conveyed, expressed or intended so to be unto the Purchaser in the manner aforesaid.

**THE VENDOR FURTHER DECLARES** that he will from time to time and at all times hereafter at the request and cost of the Purchaser, shall execute and do all act, deeds and things whatsoever for further and more effectually assuring the enjoyment and possession of the Purchaser thereof and therein as shall and may be required.

Contd. to next sheet

*My*

SHANTA AQUA REALTY PRIVATE LIMITED  
Sreenan / Karam  
Director

**IT IS FURTHER DECLARE** That there exist no charge, mortgage, attachment or any other encumbrances whatsoever upon the said land hereby transferred, expressed or intended so to be or any part thereof at the time or the execution of this deed and in the event of discovery of any charge, mortgage or attachment or any other encumbrances whatsoever, the Vendor shall be liable to compensate the Purchaser for the loss or injury that the Purchaser may sustain in consequence thereof.

**THE VENDOR FURTHER DECLARE** that if for any defect in title or any act done or suffered to be done in any way with respect to the schedule land hereby conveyed, expressed or intended so to be by these presents, the Purchaser is deprived of possession or enjoyment of the aforesaid land or any part thereof the Vendor shall be liable to refund to the Purchaser full or proportionate part of the consideration money as the case may be, together with interest at the rate of Eighteen percent per annum from the date of dispossession or deprivation and shall also be liable for adequate compensation or any loss or injury attending thereto to be sustained by the Purchaser.

**THE VENDOR FURTHER** covenant that all rents, taxes and other public charges payable for the land hereby transferred or expressed or intended so to be that have been accrued due up to the date of these presents, have been paid and all other covenants and conditions required to be observed or performed, have been so observed and performed and if it transpires otherwise, the Vendor shall be liable to indemnify the Purchaser for any loss resulting from the non-observance and non-performance as aforesaid.

**THE VENDOR FURTHER DECLARE** that the entire land forming subject matter of these presents are and were in the khas actual and physical possession of the Vendor at the date of these presents & the present position of land is Rupni & Proposed use of land is Rupni.

*Key*

Contd. to next sheet

SAHATA AGUA PRIVATE LIMITED  
D. 1936/04  
Gowen / Kumar

**IT IS FURTHER DECLARE** by the Vendor that the Vendor has not entered into any binding contract with any other person or persons whatsoever to sell or to transfer otherwise the land conveyed and transferred by these presents or expressed or intended so to be or any part thereof and there subsist no such charge, mortgage, contract of sale or transfer existing with respect to the said land or any part thereof at the date of the execution of these presents and if any of the recitals made by the Vendor, is proved to be false, the Vendor shall be liable to indemnify the Purchaser adequately for the loss or injury to be sustained by the Purchaser in consequence thereof.

### SCHEDULE

(Land hereby Sold)

All that piece or parcel of vacant land measuring **3(Three)** Kathas, appertaining to R. S. Plot No. **266** corresponding to L. R. Plot No. **219**, recorded in L. R. Khatian No. **1467**, situated at Mouza-**BARAGHARIA**, J. L. No. **82**, Pargana-Patharghata, Sheet No. **1**, Police Station-Matigara, Addl. District Sub-Registry Office Siliguri-II at Bagdogra, District-Darjeeling. The R. O. R of land is Rupni & Proposed use of land is Rupni.

The said land is identified & distinguished as marked complex Plot No. "C-12" as per site plan enclosed herewith forms part of these presents.

The said land is butted & bounded as follows:-

By the North – Complex Plot No. C-11

By the South – Complex Plot No. C-13

By the East – Complex Plot No. C-3

By the West – 18 Ft. wide Non Metal Complex Road

Contd. to next sheet

*Plan*



IN WITNESS WHEREOF THE DIRECTOR OF VENDOR IN GOOD HEALTH AND CONCIIOUS MIND HAS SUBSCRIBED ITS SEAL & PUT HIS SIGNATURE ON THIS DEED OF SALE ON THE DAY, MONTH AND YEAR FIRST ABOVE WRITTEN.

The content of this document  
has been gone through and  
understood personally by the  
Director of Vendor  
and the Purchaser

**WITNESSES:**

1. *Purna Paul*

Sri Purna Paul  
S/O Sri Narendra nath paul  
R/O-Sevoke Road, Siliguri  
P.O-Siliguri  
P.S-Bhaktinagar  
Dist. Darjeeling  
Pin-734001

2.

MAHATA AQUA PRIVATE LIMITED  
*Jeevan Kumar*  
Director  
VENDOR

Drafted and Printed in my Office  
As per instruction of the party

*Manoj Kumar Kedia*

( Manoj Kumar Kedia )  
Advocate, Siliguri  
Regn No. WB/94/1997

Contd. to next sheet

RECEIVED from the Purchaser a sum Rs.11, 14,000/-(Rupees Eleven Lakhs Fourteen Thousand) only, being the full amount of consideration money payable under these present in the manner mentioned herein below.











## MEMO OF CONSIDERATION

1. By A/C payee Cheque, being Cheque No. 378434, drawn at State Bank of India, Mangal Deep , Hill Cart Road, Siliguri, Amount Rs.11,14,000/-only in favour of "NAHATA AQUA PRIVATE LIMITED" .

Total Rs.11,14,000/-(Rupees Eleven Lakhs Fourteen Thousand) only.

  
NAHATA AQUA PRIVATE LIMITED  
VENDOR Director

## EXECUTANT





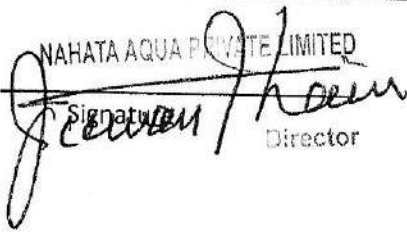

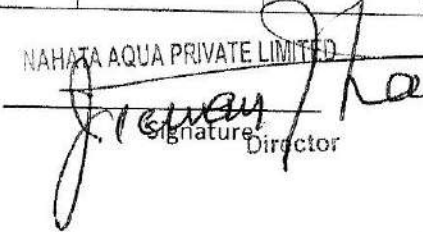



		Thumb.	Fore Finger	Middle Finger	Ring Finger	Little Finger
	Left Hand					
	Right Hand					

*Jitendra*

NAHATA AQUA PRIVATE LIMITED  
  
 Signature Director

NAHATA AQUA PRIVATE LIMITED  
  
 Signature Director

## CLAIMANT

		Thumb.	Fore Finger	Middle Finger	Ring Finger	Little Finger
	Left Hand					
	Right Hand					

*Shital Mittal*

*Shital Mittal*  
 \_\_\_\_\_  
 Signature

*Shital Mittal*  
 \_\_\_\_\_  
 Signature

**PROJECT NAME :- GOLDEN ENCLAVE PHASE-II**

LOCATION -DAGAPUR, NEAR INSTITUTE OF LEGAL STUDIES ,(LAW COLLEGE), P.O. PRADHAN NAGAR, DIST. DARJEELING. PIN-734003

**NAME OF THE PURCHASER:-**

SMT. SHITAL MITTAL  
W/O. SRI HEMANT MITTAL &  
D/O. SUMAT PRASAD AGARWAL  
RESIDING AT 13 PARK LOCATION ,  
P.O. & P.S. KURSIONG.  
DISTRICT . DARJEELING.

**NAME OF THE VENDOR:-**

NAHATA AQUA PVT. LTD.  
SEVOKE ROAD, SILIGURI,  
DISTRICT.DARJEELING  
PIN-734001  
REPRESENTED BY ITS DIRECTOR.  
1) SRI JEEWAN CHAND SHARMA @  
SRI JEEWAN SHARMA &  
S/O. LATE DEBI DUTT SHARMA.  
RESIDING AT SHAGUN APARTMENT ,  
GHANDHI ROAD, DARJEELING  
P.S. SADAR THANA, DIST. DARJEELING

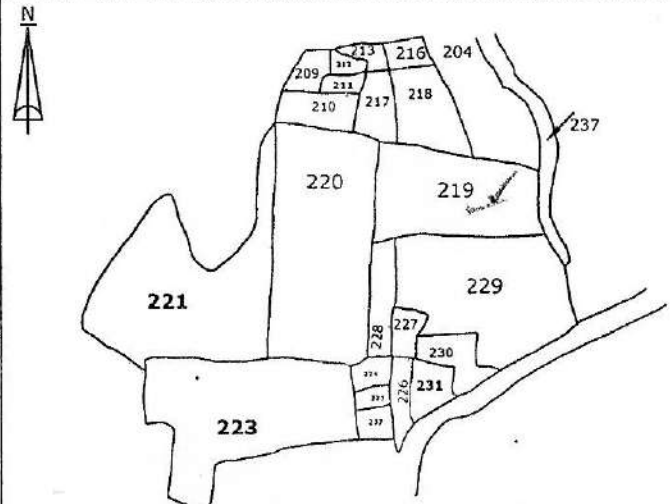

PART TRACE MAP OF MOUZA BARGHARIA, J.L.NO. 82, SHEET NO. 1,  
P.S. PRADHAN NAGAR, DIST. DARJEELING.SCALE -16"=1MILE.  
PROPOSED PLOT SHOWN

**LAND AREA :- 3.00 KATHA**

**LAND SCHEDULE :-**

MOUZA :- BARGHARIA.  
J.L.NO. :-82.  
SHEET NO. :-1  
KHATIAN NO. :-1467  
PLOT NO. :-R.S.266 L.R.219  
POLICE. STN. :- PRADHAN NAGAR,  
DISTRICT. :- DARJEELING.

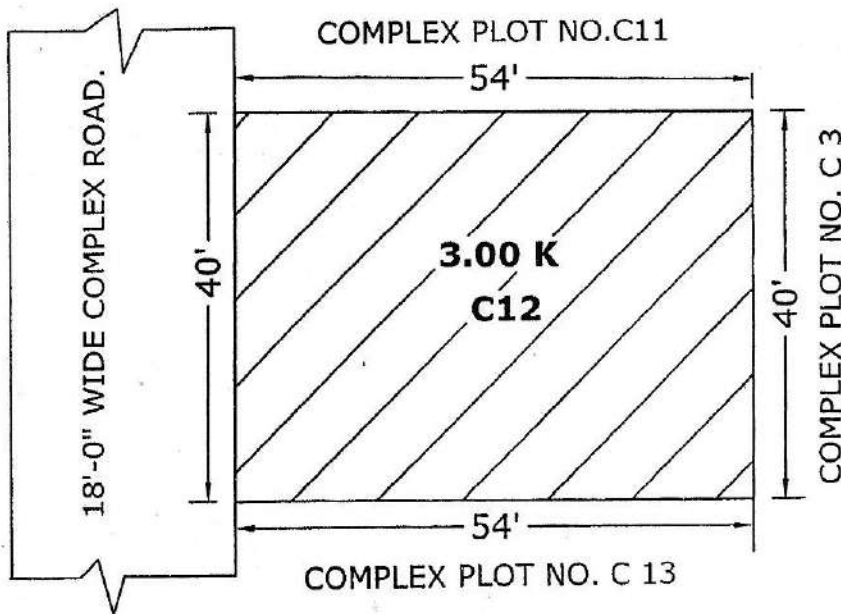

NAHATA AQUA PRIVATE LIMITED

*[Signature]*  
Director

SIGNATURE OF THE VENDOR.  
DRAWN BY:-

*[Signature]*



भारत निर्वाचन आयोग  
परिचय पत्र  
ELECTION COMMISSION OF INDIA  
IDENTITY CARD

IBN1233816



मतदाता को नाम : जिवन चन्द शर्मा  
Elector's Name : Jeewan Chand Sharma  
पिता को नाम : देवीदत्त शर्मा  
Father's Name : Debidutt Sharma  
लिंग / Sex : पं / M  
जन्म तिथि : 04/04/1958  
Date of Birth : 04/04/1958

IBN1233816

ठेकाना

गान्धी रोड, दार्जीलिंग नगरपालिका, सदर,  
दार्जीलिंग -734101

Address:

GANDHI ROAD, DARJEELING  
MUNICIPALITY, SADAR,  
DARJEELING-734101

Date: 11/03/2011

23-दार्जीलिंग निर्वाचन क्षेत्र के निर्वाचक  
रजिस्ट्रेशन अधिकारी के हस्ताक्षर की अनुकृति

Facsimile Signature of the Electoral  
Registration Officer for  
23-Darjeeling Constituency

ठेकाना परिवर्तन भएकै खण्डमा नयाँ ठेकानाको नोटर  
तालिका मा नयाँ ठेकानाको विभिन्न वी पुरानी संख्याको परिचय  
पत्र पाउनको निम्ति सटिका आवदन पत्रमा यो परिचय पत्रको  
संख्या चर्नेछ गर्नुहोस ।

In case of change in address mention this Card No.  
in the relevant Form for including your name in the  
roll at the changed address and to obtain the card  
with same number.

1280928

आयकर विभाग  
INCOME TAX DEPARTMENT



भारत सरकार  
GOVT. OF INDIA

NAHATA AQUA PRIVATE LIMITED

12/08/2010  
Permanent Account Number

AAECN4576F

28/09/2013

NAHATA AQUA PRIVATE LIMITED

*Jewar Lal*  
Director

ভাৰত চৰকাৰ  
Government of India



পূৰ্ণ পাল  
PURNA PAL  
পিতা : নৱেন পাল  
Father: Naren Pal  
জন্মতাৰিখ / DOB : 07/02/1990  
পুলক / Male



7620 4757 0268

আধাৰ - সাধাৰণ মানুহৰ অধিকাৰ

*Purna Pal*

ভাৰত চৰকাৰ  
Unique Identification Authority of India

ঠিকানা:  
- , বিনাক পাড়া, কুশমন্ডি, -  
উখালিয়া, কুশমন্ডি, পশ্চিম  
দিনাজপুৰ, পশ্চিম বং. 733132

Address:  
- , Binak para, KUSHMANDI, -  
Ukhaliã, Kushmandi, South  
Dinajpur, West Bengal, 733132

7620 4757 0268

1947  
1800 300 1947

help@uidai.gov.in

www  
www.uidai.gov.in

आयकर विभाग  
INCOME TAX DEPARTMENT



भारत सरकार  
GOVT. OF INDIA

SHITAL MITTAL

SUMAT PRASAD AGARWAL

31/01/1987

Permanent Account Number

AIJPA8496Q

*Shital Mittal*

Signature

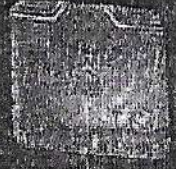

21/01/2016









Government of West Bengal

Department of Finance (Revenue) , Directorate of Registration and Stamp Revenue

OFFICE OF THE A.D.S.R. BAGDOGRA, District Name :Darjeeling

Signature / LTI Sheet of Query No/Year 04030000855171/2019

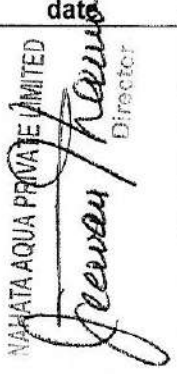
I. Signature of the Person(s) admitting the Execution at Private Residence.

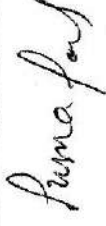
SI No.	Name of the Executant	Category	Photo	Finger Print	Signature with date
1	Shri JEEWAN CHAND SHARMA SHAGUN APARTMENT, GANDHI ROAD, P.O:- DARJEELING, P.S:- Darjeeling, Darjeeling, District:-Darjeeling, West Bengal, India, PIN - 734101	Representative of Seller [NAHATA AQUA PRIVATE LIMITED ]			
SI No.	Name and Address of identifier	Identifier of	Photo	Finger Print	Signature with date
1	Mr PURNA PAUL Son of Shri NARENDRA NATH PAUL SEVOKE ROAD, SILIGURI, P.O:- SILIGURI, P.S:- Bhaktinagar, District:-Jalpaiguri, West Bengal, India, PIN - 734001	Shri JEEWAN CHAND SHARMA			

(Suraj Lepcha)

ADDITIONAL DISTRICT  
SUB-REGISTRAR  
OFFICE OF THE A.D.S.R.  
BAGDOGRA  
Darjeeling, West Bengal

## Major Information of the Deed

Deed No :	I-0403-03336/2019	Date of Registration	17/06/2019
Query No / Year	0403-0000855171/2019	Office where deed is registered	
Query Date	05/06/2019 12:02:29 PM	A.D.S.R. BAGDOGRA, District: Darjeeling	
Applicant Name, Address & Other Details	MANOJ KEDIA KHALPARA,SILIGURI,Thana : Siliguri, District : Darjeeling, WEST BENGAL, Mobile No. : 9832016171, Status :Advocate		
Transaction	Additional Transaction		
[0101] Sale, Sale Document	[4305] Other than Immovable Property, Declaration [No of Declaration : 1], [4308] Other than Immovable Property, Agreement [No of Agreement : 1]		
Set Forth value	Market Value		
Rs. 11,14,000/-	Rs. 11,14,000/-		
Stampduty Paid(SD)	Registration Fee Paid		
Rs. 55,720/- (Article:23)	Rs. 11,154/- (Article:A(1), E, E)		
Remarks			

### Land Details :

District: Darjeeling, P.S:- Matigara, Gram Panchayat: PATHARGHATA, Mouza: Baragharia-(082) Pin Code : 734010

Sch No	Plot Number	Khatian Number	Land Proposed	Use ROR	Area of Land	SetForth Value (In Rs.)	Market Value (In Rs.)	Other Details
L1	LR-219 (RS :-)	LR-1467	Rupni	Rupni	3 Katha	11,14,000/-	11,14,000/-	Width of Approach Road: 18 Ft.,
<b>Grand Total :</b>					<b>4.95Dec</b>	<b>11,14,000 /-</b>	<b>11,14,000 /-</b>	

### Seller Details :

Sl No	Name,Address,Photo,Finger print and Signature
1	<b>NAHATA AQUA PRIVATE LIMITED</b> 404,GANGA APARTMENT,MANGAL PANDEY ROAD,KHALPARA,, P.O:- SILIGURI, P.S:- Siliguri, Siliguri Mc, District:-Darjeeling, West Bengal, India, PIN - 734005 , PAN No.:: AAECN4576F, Status :Organization, Executed by: Representative, Executed by: Representative

### Buyer Details :

Sl No	Name,Address,Photo,Finger print and Signature
1	<b>Smt SHITAL MITTAL</b> Wife of Shri HEMANT MITTAL 13 PARK LOCATION,KURSEONG, P.O:- KURSEONG, P.S:- Kurseong, Kurseong, District:-Darjeeling, West Bengal, India, PIN - 734203 Sex: Female, By Caste: Hindu, Occupation: Business, Citizen of: India, PAN No.:: AIUPA8496Q, Status :Individual, Status : Not Executed

**Representative Details :**

Sl No	Name,Address,Photo,Finger print and Signature
1	<b>Shri JEEWAN CHAND SHARMA (Presentant )</b> Son of Late DEBI DUTT SHARMA SHAGUN APARTMENT,GANDHI ROAD, P.O:- DARJEELING, P.S:- Darjeeling, Darjeeling, District:-Darjeeling, West Bengal, India, PIN - 734101, Sex: Male, By Caste: Hindu, Occupation: Business, Citizen of: India, , PAN No.:: AKVPS8264M Status : Representative, Representative of : NAHATA AQUA PRIVATE LIMITED (as DIRECTOR)

**Identifier Details :**

Name	Photo	Finger Print	Signature
<b>Mr PURNA PAUL</b> Son of Shri NARENDRA NATH PAUL SEVOKE ROAD,SILIGURI, P.O:- SILIGURI, P.S:- Bhaktinagar, District:-Jalpaiguri, West Bengal, India, PIN - 734001			
Identifier Of Shri JEEWAN CHAND SHARMA			

**Transfer of property for L1**

Sl.No	From	To. with area (Name-Area)
1	NAHATA AQUA PRIVATE LIMITED	Smt SHITAL MITTAL-4.95 Dec

**Land Details as per Land Record**

District: Darjeeling, P.S:- Matigara, Gram Panchayat: PATHARGHATA, Mouza: Baragharia-(082) Pin Code : 734010

Sch No	Plot & Khatian Number	Details Of Land	Owner name in English as selected by Applicant
L1	LR Plot No:- 219, LR Khatian No:- 1467	Owner:নাহাটা একোয়া প্রাইভেট লি., Gurdian:ডা:সান্ন সিংহা, Address:খালপাড়া, শিলিগুড়ি , Classification:রূপনী, Area:0.12090000 Acre,	NAHATA AQUA PRIVATE LIMITED

**Endorsement For Deed Number : I - 040303336 / 2019****On 12-06-2019****Presentation(Under Section 52 & Rule 22A(3) 46(1),W.B. Registration Rules,1962)**

Presented for registration at 13:09 hrs on 12-06-2019, at the Private residence by Shri JEEWAN CHAND SHARMA

**Certificate of Market Value(WB PUVI rules of 2001)**

Certified that the market value of this property which is the subject matter of the deed has been assessed at Rs 11,14,000/-

**Admission of Execution ( Under Section 58, W.B. Registration Rules, 1962 ) [Representative]**

Execution is admitted on 12-06-2019 by Shri JEEWAN CHAND SHARMA, DIRECTOR, NAHATA AQUA PRIVATE LIMITED (Private Limited Company), 404,GANGA APARTMENT,MANGAL PANDEY ROAD,KHALPARA,, P.O:- SILIGURI, P.S:- Siliguri, Siliguri Mc, District:-Darjeeling, West Bengal, India, PIN - 734005

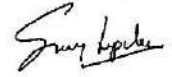

Suraj Lepcha  
ADDITIONAL DISTRICT SUB-REGISTRAR  
OFFICE OF THE A.D.S.R. BAGDOGRA  
Darjeeling, West Bengal

On 17-06-2019

Certificate of Admissibility (Rule 43, W.B. Registration Rules 1962)

Admissible under rule 21 of West Bengal Registration Rule, 1962 duly stamped under schedule 1A, Article number : 23 of Indian Stamp Act 1899.

Payment of Fees

Certified that required Registration Fees payable for this document is Rs 11,154/- ( A(1) = Rs 11,140/- , E = Rs 14/- ) and Registration Fees paid by Cash Rs 0/-, by online = Rs 11,154/-

Description of Online Payment using Government Receipt Portal System (GRIPS), Finance Department, Govt. of WB  
Online on 13/06/2019 3:38PM with Govt. Ref. No: 192019200024780291 on 13-06-2019, Amount Rs: 11,154/-, Bank: AXIS Bank ( UTIB0000005), Ref. No. 304292594 on 13-06-2019, Head of Account 0030-03-104-001-16

Payment of Stamp Duty

Certified that required Stamp Duty payable for this document is Rs. 55,720/- and Stamp Duty paid by Stamp Rs 5,000/- by online = Rs 50,720/-

Description of Stamp

1. Stamp: Type: Court Fees, Amount: Rs.10/-

2. Stamp: Type: Impressed, Serial no 5277, Amount: Rs.5,000/-, Date of Purchase: 03/05/2019, Vendor name: J R Das

Description of Online Payment using Government Receipt Portal System (GRIPS), Finance Department, Govt. of WB  
Online on 13/06/2019 3:38PM with Govt. Ref. No: 192019200024780291 on 13-06-2019, Amount Rs: 50,720/-, Bank: AXIS Bank ( UTIB0000005), Ref. No. 304292594 on 13-06-2019, Head of Account 0030-02-103-003-02

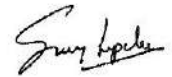

Suraj Lepcha  
ADDITIONAL DISTRICT SUB-REGISTRAR  
OFFICE OF THE A.D.S.R. BAGDOGRA  
Darjeeling, West Bengal

Certificate of Registration under section 60 and Rule 69.

Registered in Book - I

Volume number 0403-2019, Page from 74417 to 74438

being No 040303336 for the year 2019.



*Suraj Lepcha*

Digitally signed by SURAJ LEPCHA  
Date: 2019.06.17 15:23:18 +05:30  
Reason: Digital Signing of Deed.

(Suraj Lepcha) 17/06/2019 15:23:08  
ADDITIONAL DISTRICT SUB-REGISTRAR  
OFFICE OF THE A.D.S.R. BAGDOGRA  
West Bengal.

(This document is digitally signed.)